



**Three-phase Filter Reactor**

<b>Design</b>	Three-phase, iron-core with air gaps, PolyGap(R) core design
<b>Impregnation</b>	Complete unit vacuum-overpressure impregnated with varnish acc. to temperature class H and temperature hardened in furnace
<b>Harmonic load design</b>	Voltages distortion based on UN : u1=106% u3=0.5% u5=5% u7=5%

**Technical Data**

<b>No. of phases</b>		3
<b>Rated voltage</b>	Un/V	480
<b>Rated frequency</b>	fn/Hz	60
<b>Reactive power</b>	Nc/kVAr	43
<b>Capacitor (star connection)</b>	Cy/μF	460.5
<b>Reactance factor</b>	p/%	7
<b>Resonance frequency</b>	fr/Hz	226.78
<b>Rated inductivity</b>	Ln/mH	3 x 1.07
<b>Negative tolerance</b>	%	-2
<b>Positive tolerance</b>	%	+3
<b>RMS current</b>	Irms/A	57.6
<b>Limit of linearity</b>	Ilin/A	96
<b>Losses of fundamental</b>	Nv1/W	160
<b>Total losses</b>	Nvsum/W	220
<b>Mass /kg</b>	m/kg	26

**Current spectrum** 90887

n	f/Hz	I/A	U/UN /%	Voltage@reactor/V
1	60	54.84	106	22.1
3	180	1.95	0.5	2.4
5	300	16.04	5	32.3
7	420	6.93	5	19.6

# Datasheet **Vorläufige Daten/Preliminary Data**



Type number: 1048216

Customer part name: DTR-07-480-60-K040

## Operating conditions

<b>Protection class</b>		IP00, Indoor operation	
<b>Operation mode</b>		Continuous mode	
<b>Duty cycle</b>	%	100	
<b>Maximum levitation</b>	masl	1,000	
<b>Type of cooling</b>		AN	natural convection
<b>Isolation class</b>		T50/H	
<b>Minimum ambient temperature</b>	Tamin/°C	5	no condensing, no ice
<b>Maximum ambient temperature</b>	Tamax/°C	50	
<b>Allowed temperature rise</b>	dT/K	115	utilized acc. to isolation class H
<b>Temperature sensor</b>		Yes	
<b>Temperature sensor middle coil</b>		T10/180 NC (H)	

## Standards

<b>IEC standards</b>	IEC/EN60076-6 VDE0532-76-6
<b>UL approval</b>	UL file E173113 class H
<b>Seperate source voltage</b>	UAC/kV (1 min)   3

## Mechanical characteristics

<b>Winding material Cu/Al</b>	Al
<b>Terminal 1</b>	Cu bar 20 x 3 mm <sup>2</sup> / 9mm
<b>Terminal 2</b>	Cu bar 20 x 3 mm <sup>2</sup> / 9mm

## Approximate dimensions

90883

zeichnungen/pre/CU1\_oPE\_mT\_1s\_verlaengert.JPG

Description	Value
A/mm	260
B/mm	240
C/mm	142
D/mm	200
E/mm	150
F/mm	88
G/mm	102
H/mm	132
d1/mm	10
d2/mm	11
d3/mm	11

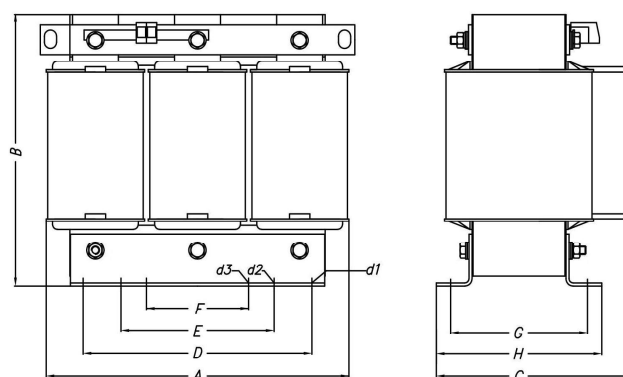

# Datasheet **Vorläufige Daten/Preliminary Data**



Type number: **1048216**

Customer part name: **DTR-07-480-60-K040**

## Warnungen



Nichtbeachtung dieser Hinweise kann zu schweren Verletzungen bis hin zum Tode sowie zur Zerstörung dieses oder angeschlossener Produkte führen!

Im Betrieb können die Produkte hohe Spannungen aufweisen. Berühren Sie die Produkte nicht und schützen Sie die Produkte gegen Berührung.

Stellen Sie vor Installations- oder Wartungsarbeiten sicher, dass die Produkte spannungsfrei geschaltet sind und keine Restspannungen mehr aufweisen.

Betreiben Sie keine Produkte, die beschädigt sind.

Die Installation darf nur von fachlich geschultem Personal durchgeführt werden.

Die angegebenen technischen Daten sind typisch. Aufgrund von Material- und Fertigungseigenschaften können Abweichungen auftreten. Änderungen vorbehalten.

## Cautions



Noncompliance with these instructions may lead to serious injury, death, or damage to the products and connected equipment.

All electrically active parts may carry high voltages. Do not touch the products during operation and protect the products against accidental contact.

Before any assembly or maintenance make sure that all equipment is disconnected from the power source and is free of residual voltage.

Do not install products in case of any visible damage. Installation must be done by skilled personnel only.

All given technical specification are typical. Material and production tolerances may cause variations. This datasheet may be subject to change.

## Typenschild / Name Plate

zeichnungen/tschild/pdf/AK1048216.JPG

	<b>Hans von Mangoldt GmbH &amp; Co.KG</b> Hergelsbendenstr. 18 52080 Aachen, Germany		
<b>FILTER REACTOR DTR-07-480-60-K040</b>			
TYP	1048216	Nr {999999999}	IEC60076
LN/mH	1,070	UN/V 480	IP00
IN/A	51,7	fN/Hz 60	{9999}
Irms/A	57,6	ED/% 100	26,3 kg
Qk/kvar	43	p/% 7	AN-T50/H
Made in Germany			